

30008 / 1.4 / 2024-03-18 / LD-MH / EN-NA

Installation and operating instructions Electro-magnetic Flow Meter FMQ



Note

The contents of this document are the intellectual property of Anderson-Negele. Any reproduction or translation without written permission is prohibited.

Please read these installation and operating instructions carefully. All instructions in this manual must be followed exactly to ensure proper operation of the unit.

If you have any questions regarding the product, installation or commissioning, please contact Anderson-Negele Support at support under:

America:
Phone 800-833-0081
techservice@anderson-negele.com

Other countries:
Phone +49-8333-9204720
support@anderson-negele.com



Table of contents

1.	General description	1
1.1.	Preface	1
1.2.	Function	1
1.3.	Technical data	1
1.3.1.	Converter	1
1.3.2.	Transmitter in compact design	2
1.3.3.	Measuring ranges	2
2.	Safety instructions.....	3
2.1.	General remarks	3
2.1.1.	Special attention of the user.....	3
2.1.2.	General safety instructions.....	4
2.2.	Intended use	5
2.3.	Special safety instructions and devices	6
2.4.	Explanation of the safety symbols used.....	6
3.	Transport.....	7
3.1.	General information	7
3.2.	Special notes	7
3.3.	Dimensions and weight.....	8
3.3.1.	Compact version	8
3.3.2.	Dimensions of the process connections	9
4.	Mounting.....	9
4.1.	Conditions required for the transmitter	10
4.1.1.	Air and gas.....	10
4.1.2.	Particulates/Solids.....	10
4.1.3.	Fitting position – electrode axis	11
4.1.4.	Inlet and outlet pipe sections.....	13
4.1.5.	Conductivity conditions	13
4.1.6.	Interference fields	14
4.1.7.	Earthing/grounding conditions.....	14
4.1.8.	Meter tube lining	14
4.2.	Flow direction	15
4.3.	Conditions required for the converter	15
4.4.	Alignment of the converter	16
4.5.	Welding work	16
4.6.	Cover	17
5.	Installation.....	18
5.1.	Installation instructions for the transmitter	18
5.2.	Installation instructions for the converter	19
5.2.1.	Installation of the electrical power supply	19
5.2.2.	DC Input	20
5.2.3.	Digital output.....	20
5.2.4.	Analog output - current output.....	21
5.2.5.	Optional digital Input.....	21

Table of content

5.3	Wiring of the Remote Configuration Converter to the Transmitter Fehler!	
	Textmarke nicht definiert.	
5.4	Display	21
6	Commissioning	23
6.1	General information	23
6.2	Advice for starting-up the FMQ	24
6.3	Basic settings upon delivery	24
6.3.1	System structure and operating elements	24
6.4.	Zero point adjustment (“ZERO adjust”)	25
6.5	Metering with an empty meter tube	25
6.5.1	"EMPTY pipe detection"	25
6.6	External reset of counter (use of digital input)	25
6.7	Status indication	26
6.8	Optical operating elements (display version)	26
7	Operation	27
7.1	Basic keypad functions	28
7.2	Display navigator	28
7.3.1	Zero reset of the volume counter	31
7.3.2	How to delete malfunction messages.....	31
7.3.3	Parameter change	31
7.3.4	How to release a parameter change:	32
7.3.5	How to release the service functions:.....	32
7.3	Display level: Measured values	33
7.4.1	Measured value: Volume	33
7.4.2	Measured value: Flow rate.....	33
7.4.3	Measured value: Flow rate and volume	33
7.4.4	Measured value: Total quantity	33
7.4.5	Error message: Transmitter not connected	34
7.4	Display level: Base parameters	34
7.5.1	Language	34
7.5.2	CS3Bus address.....	34
7.5.3	Dimension.....	35
7.5.4	QTYP.....	35
7.5	Display level: Pulse output	36
7.6.1	PV1.....	36
7.6.2	TP1.....	36
7.6.3	IT1	36
7.6	Display level: Digital input	37
7.7.1	Function: Digital input	37
7.7.2	IT1	37
7.8	Display level: Current output	37
7.8.1	Qmax.....	37
7.8.2	TP3.....	38
7.9	Display level: Metering parameters	38
7.9.1	LFS.....	39
7.9.2	MSPE	39
7.9.3	BSPE	39
7.9.4	Average	39
7.9.5	Offset.....	40
7.9.6	SPAN.....	40
7.9.7	Pipe Detect (recognition of an empty meter tube)	40

Table of contents

7.9.8	Nominal width	40
7.10	Display level: Special functions	40
7.10.1	Zero adjust.....	41
7.10.2	Factory settings	41
7.10.3	LCD contrast.....	41
7.11	Display level: Service level	42
7.11.1	Error register: Metering	42
7.11.2	Error register: Operating system	42
7.11.3	Simulation of the current output	42
7.11.4	Simulation of the pulse outputs	43
7.11.5	Simulation of the flow rate.....	43
7.12	Display level: Info	43
7.12.1	Info1.....	43
7.12.2	Info2.....	44
7.12.3	Info3.....	44
7.13	LOCK switch	44
8	Parameterization.....	45
8.1	Adjustments.....	45
8.1.1	Adjustment by calibration factor "m spe"	48
8.2	Measuring accuracy	49
9	Trouble-shooting	50
9.1	Error diagnosis.....	50
9.1.1	Error diagnosis via the display	50
9.1.2	Error list	51
9.2	Typical effects or error sources	52
9.2.1	Flow without flow rate indication:.....	52
9.2.2	No pulse transmission despite displayed flow	52
9.2.3	No analog signal available	53
9.2.4	Deviations of measured values	54
9.3	Error reset.....	55
9.4	Transmitter tests	55
9.4.1	Visual test	55
10	Maintenance.....	56
10.1	Safety instructions for maintenance work.....	56
10.2	Routine maintenance	56
10.2.1	Preventive maintenance steps	57
10.3	Repairs	58
10.3.1	Sending-in the flow meter to the manufacturer.....	58
10.3.2	Repair work.....	58
10.3.2.1	Replacement of the sealing cover of the operating unit	59
10.3.2.2	Replacement of the transmitter	59
10.4	Special program functions.....	59
10.4.1	Flow simulation	59
10.4.2	Simulation via the display unit.....	59
10.5	Spare parts to be kept available on your stock.....	59
11	Decommissioning.....	60
11.1	Temporary decommissioning.....	60
11.2	Final decommissioning / disposal.....	60

1. General description

1.1. Preface

This documentation includes some information protected by copyright. Without prior authorization by **Anderson-Negele** this instruction manual is not allowed to be photocopied, copied, duplicated, translated, or recorded on data carriers (neither completely nor in extracts).

This instruction manual should be carefully read before the installation and operation of the device is started. It has to be deposited in the direct vicinity of the device described, easily accessible to all persons concerned.

The safety instructions have to be strictly observed.

Anderson-Negele cannot assume any liability or legal responsibility for operating errors caused by the non-observance of these directions.

1.2. Function

The electromagnetic flow meter, type FMQ, measures both the flow rate and the volume of liquid flows at a high precision.

The measuring device is suitable for measuring conductive liquids in principle.

The FMQ converter is microprocessor controlled. It supplies the transmitter with a switched and regulated coil current.

The signal generated at the electrodes is amplified in the converter, conditioned and shown in the internal measuring registers both as flow rate and volume information.

Volume pulses (pulses per volume unit) are output for controlling and regulating purposes.

The instantaneous flow rate is output as an analog signal of 4...20 mA according to the desired range of 0...100 %.

When leaving the factory, each device is adjusted in such a way that only the power supply and any peripherals will have to be connected.

1.3. Technical data

1.3.1. Converter

Supply voltage:	FMQ DC: 24V ±10% DC
Power consumption:	4 watts max.
Electrical fuse connection:	DC power supply: T 1A
Digital pulse output / IO-Link : Maximum load:	1 x output, active 32 V / 20 mA / pulse sequence: 1 kHz max.
Analog output:	4 - 20 mA ±0.1 mA (active), maximum load 500 Ω
Ambient temperature:	-20°C ... +60°C

Voltage peaks of up to 200mA can occur during switch-on

1.3.2. Transmitter

Transmitter		Compact version	
Process connections:		Aseptic flange	
Optional adapters:		ASME Clamp,DIN Clamp,butt-weld	
Nominal widths:		DN 10, 15, 25, 32, 40, 50, 65, 80, 100	
Materials:		Meter tube:	
Materials:	Liner:	PFA	
	Electrodes:	Material no.:	1.4404 / AISI 316 L
	Housing:	Material no.:	1.4301 / AISI 304
Protection class:		IP67	
Electrical connection:		M12 electrical connection	
Product temperature:		100°C max.	
Cleaning temperature:		130°C for a maximum period of 30 minutes	
Product conductivity:		5 µS/cm at a minimum, see item conductivity conditions	
Admissible pressure*:		Minimum: 0.5 bar abs. at 20°C; Maximum: 16 bar (DN10 – DN100)	
Flow velocities:		0.1 - 10 m/s	

* The pressure rating depends on the process connection and the seals and gaskets used.

1.3.3. Measuring ranges

DN	Total flow range [L/h]			Flow rate at a Flow velocity of 1 m/s [L]	Unit
		-			
10	30	-	3,000	300	L/h
15	70	-	7,000	700	L/h
25	180	-	18,000	1,800	L/h
32	300	-	30,000	3,000	L/h
40	450	-	45,000	4,500	L/h
50	700	-	70,000	7,000	L/h
65	1,200	-	120,000	12,000	L/h
80	1,800	-	180,000	18,000	L/h
100	2,800	-	280,000	28,000	L/h

2. Safety instructions

Due to the great variety of possible conditions of use, this instruction manual can consider the general kind of application only.

Special cases such as extraordinary ambient conditions or special safety instructions require coordination with the manufacturer.

2.1. General remarks

2.1.1. Special diligence of the user

This measuring instrument has been designed and built in consideration of a risk analysis and after a careful choice of the harmonized standards and further technical specifications to be kept. It corresponds to the state of the art and offers an optimum safety.

The user of the flow meter is responsible for any inputs of special parameters.

In practical use, however, that degree of safety can only be obtained when all measures required in this respect will be really taken. It belongs to the diligence of the user of the flow meter to plan such measures and to check and survey if they are really fulfilled.

In particular, the user has to ensure that:

- The measuring instrument is only used for the intended application as directed (also see the following chapter "Intended use").
- The measuring instrument is operated in a perfect and functioning condition and that especially the safety devices are regularly checked for their proper operation.
- The personal protective equipment required for the operating, maintenance, and repair staff is kept available and really used.
- The complete instruction manual in a legible condition is permanently available at the location of the measuring device.
- The device is operated, serviced, and repaired by sufficiently qualified and authorized personnel only.
- The personnel concerned is regularly trained for all applicable questions of the protection of labour and environment and familiarized with the instruction manual and especially the safety precautions included therein.
- All the safety and warning instructions attached to the measuring instrument are not removed and kept in a legible condition.

In case of problems that he cannot remove on his own, the user of the system should contact the service department of **Anderson-Negele**.

2.1.2. General safety instructions

These safety instructions have to be strictly observed in order:

- To not endanger the safety of persons and environment
- To avoid any damages to the measuring instrument
- To prevent any faulty batches upon the production

The electric connection may only be carried out by persons who have got the necessary expert knowledge (e.g. trained electrical fitters or persons instructed in electrical engineering) and the necessary authorization from the user.



Beware of
dangerous voltage!

**Unauthorized persons are not allowed to
open a housing that shows this symbol!**



Important
information

The wiring of the voltage supply and the inputs and outputs of the control circuits has to be carried out professionally in consideration of the up-to-date state of the art. Also refer to **chapter 5** "Installation"/"Electrical Connection".

In particular, the following references have to be observed:

- Safety instructions
 - Electrical connection data
1. All persons who are involved in the installation, commissioning, operation, service, and maintenance of the flow meter have to be qualified accordingly.
 2. This instruction manual has to be strictly observed. The user of the flow meter has to guarantee that the personnel concerned has read and fully understood the instruction manual.
 3. All kinds of work have to be done with utmost care and may be carried out by accordingly authorized and trained personnel only. At any rate the directives of the respective country for opening and repairing the devices have to be considered.
 4. The instruction manual has to be available close to the flow meter, easily accessible to the operating staff.
 5. Before starting any cleaning, conversion, service or maintenance work, the measuring device has to be switched off and separated from the mains supply. This requires a device for separating all live wires, e.g. a 2-pole main switch in the control cabinet. The associated device has to be protected against unauthorized switching-on.
 6. Before starting any service and maintenance work, the system has to be flushed with water and emptied. If the flow meter has to be removed from the pipe system, all pipelines will have to be previously emptied and protected by means of some appropriate emptying and shut-off measures.
 7. The flow meter fulfils the general safety requirements according to EN 61010.
 8. Never remove or put out of action any safety devices by modifications to the flow meter!
 9. Do not touch any parts flown through by the medium while the measuring instrument is cleaned. Otherwise, you run the risk of getting burnt!

Safety instructions

10. To minimize the danger of injury, the working area of the operator has to allow sufficiently free space.
11. The technical data according to the instruction manual, nameplate and, if available, the performance specification has to be considered.

If damage is caused due to an inexpert performance of work any warranty claims will definitely extinguish.

Dangers not resulting from the functionality of the device, but from the ambient and operating conditions prevailing at the place of application, have to be referred to in appropriate instructions to the operators and by the attachment of some danger signs!

The user of the device is exclusively responsible for the compliance with these instructions!

2.2. Intended use

The measuring instrument is only allowed to be used for the application that it has been designed, dimensioned and built for:

- the connection to an earthed monophase network or a direct current network (see the nameplate)
- in industrial areas according to EN 61000-6-2/4 for reasons of EMC

The intended purpose of the electromagnetic flow meter is the measurement of conductive liquids in the food processing industry and in the cosmetic, pharmaceutical and chemical industries.

This flow meter is *not* suitable for the measurement of hazardous, explosive, and combustible liquids according to the Pressure Equipment Directive 97/23/EC, category 1.

The nominal widths up to DN 50 are manufactured in consideration of our "many years of engineering experience". The nominal widths larger than DN 65 are subject to category I of the Pressure Equipment Directive 97/23/EC and the Conformity Assessment Procedure, Module A.

The intended use of the device has to be strictly observed by the user.

Any modifications to the measuring device that might have an influence on the function and the safety devices of the flow meter are only allowed to be carried out by the engineering specialists or authorized persons of Anderson-Negele.

Possible misuse

Any utilisation being in contradiction to the above-mentioned application means an inadmissible misuse of the measuring instrument! In such a case Anderson-Negele does not assume any responsibility for the safety.

Anderson-Negele has to be contacted before the flow meter will be used for any different application, and after a careful investigation of all facts Anderson-Negele could possibly release the flow meter for the intended new application.











2.3. Special safety instructions and devices

The following dangers could be directly or indirectly caused by the flow meter, type FMQ, during operation or commissioning:

- Electric shock if the electronic housing is opened improperly
- Burns by touching hot pipe sections
- Scalds and/or chemical burns by hot liquids or gas coming out through leaking flange connections or because of an inexperienced opening of the pipe system

2.4. Explanation of the safety symbols used

The FMQ flow meters are reliable in operation and meet the highest technical specifications. They leave our factory at a safety-related flawless condition. The devices correspond to the relevant standards and directives according to EN 61010 "Electrical safety testing for measurement and laboratory devices". However, a hazard can originate from the devices, if they are used inexpertly and not for their intended purpose. Therefore, strictly observe the safety instructions of this instruction manual which are marked by the following symbols:

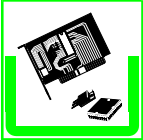
 <p>Important Information</p>	 <p>Hot caustic solution can cause serious chemical burns</p>	 <p>Attention Caution</p>
 <p>Beware of hazardous electric tension</p>	 <p>Beware of hand injuries!</p>	 <p>Beware of hot surfaces!</p>
 <p>Beware of hot liquids and steams</p>	 <p>Beware of media detrimental to health or irritating substances!</p>	 <p>Beware of an increased risk of skidding in wet areas!</p>
 <p>Electrostatically endangered system component</p>	 <p>Electronic scrap</p>	

3. Transport

3.1. General information

The following points have to be respected in order to avoid damages to the measuring instrument or injuries during the transport of the device:



Caution

Transport work is only allowed to be carried out:

- **By accordingly qualified and authorized persons**
- **By the aid of appropriate load suspension and fastening devices**
- **On the condition that any risk can be fully excluded while the device is lifted or conveyed**

The packing of the measuring instruments is subject to the following labelling:



Fragile goods



Keep dry!

Check the added packing list before you will start opening the packing!
Compare by means of the packing list if all parts are really available or not!
Treat sensitive parts with special care!

Please do not fail to dispose of the packing material according to the appropriate regulations.

3.2. Special notes

When removing the packaging film, see to it that no components of the device (such as display or keypad) are damaged or destroyed.

3.3. Dimensions and weight

3.3.1. Compact version

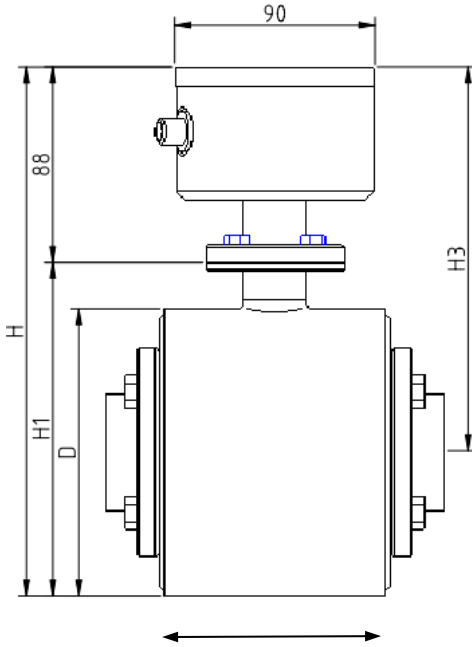

DN	W [mm]	D [mm]	H [mm]	H1 [mm]	H3 [mm]	Weight [kg]
10	104	90	190	110	145	6.0
15	104	90	190	110	145	5.8
25	104	90	190	110	145	5.6
32	104	105	205	125	153	6.4
40	104	105	205	125	153	6.4
50	104	130	230	150	165	7.9
65	160	130	230	150	165	8.8
80	160	155	255	175	178	11.2
100	200	170	270	190	188	13.2

3.3.2. Dimensions of the process connections

The welding socket belongs to the standard delivery.

If a flow meter of the previous series IZM-S™ or IZM-L™ is replaced by a FMQ, adapters up to DN 100 are required.

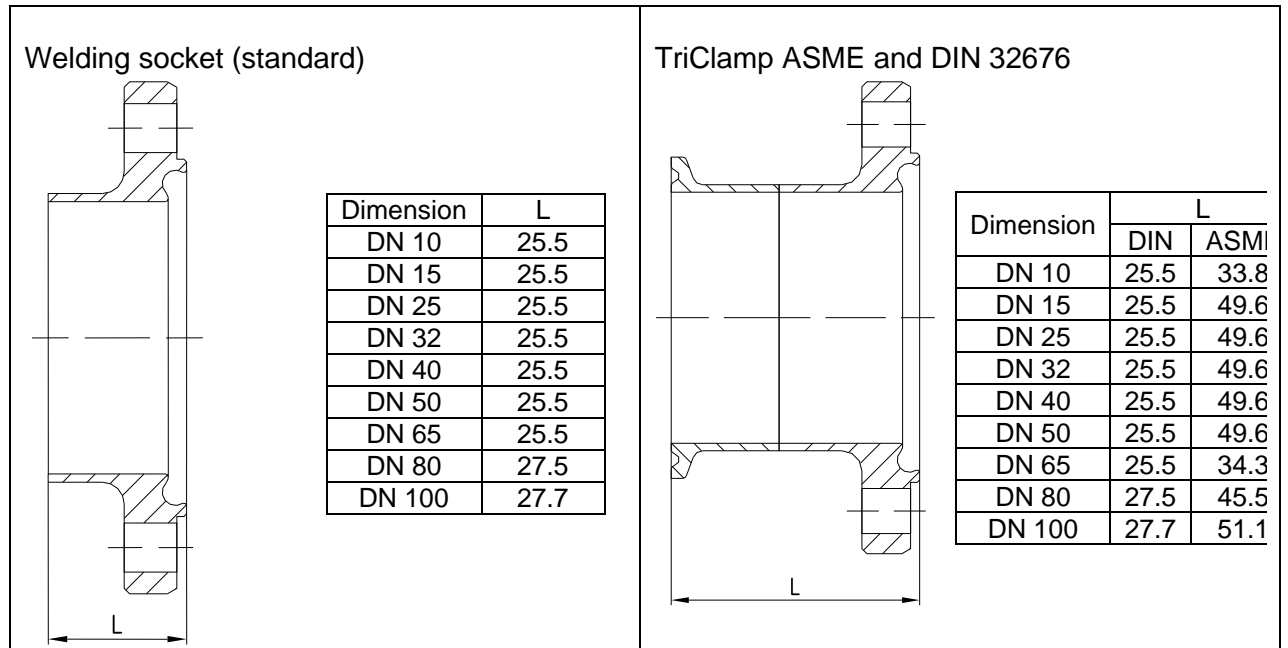

4. Mounting

4.1. Conditions required for the transmitter

In any case the transmitter has to be installed in the product line and the converter has to be supplied with voltage.

When selecting the place for the installation of the measuring instrument you should in any rate ensure that the housing can be opened for service work whenever desired and that the flow meter can be simply removed, if necessary.

Equalising currents between the transmitter and the converter have to be absolutely avoided, as they will cause measuring errors.



To protect the transmitter against damage, select the place of installation so that:

Caution

- the process pressure is always kept below the admissible operating pressure
- the product temperature is always kept below the admissible temperature
- the transmitter is mechanically levelled out (e.g. to avoid vibration)
- the meter tube can be emptied in case of the danger of frost
- the measuring instrument is not arranged straight above a gully or sink hole
- the connection housing is not permanently exposed to drip water

4.1.1. Parts of air and gas

The electromagnetic measuring instrument can supply perfect measuring results in case of **gas-free liquids** only. Air locks or deaeration in a liquid will lead to faulty measurements.

Thus, make sure that air locks or other possible parts of gas are safely separated before the measuring device e.g. by gas separators or that deaeration can be excluded by a sufficient working pressure.

The measuring device is not damaged e.g. by air locks.

4.1.2. Particulates and Solids

Normally, solid parts do not have any negative influence on the volume measurement.

The pipe diameter should always be chosen sufficiently large in order to prevent the meter tube from being clogged in case of products including solid particles.

Due to the fact that the flow velocity of solid matters is relatively lower than that of the liquid part of the product, a higher flow fluctuation could be caused while the flow rate is determined.

The measurement of abrasive materials can cause a drifting of the measuring accuracies and, in the end, a deterioration of the transmitter.

4.1.3. Fitting position – electrode axis

Due to the principle described, the fitting position – to a certain extent – can be selected any way desired. The basic condition for accurate measuring results is, however, a full and gas-free meter tube.

If possible, the electrode axis should be horizontally arranged, in order to avoid a deposition of gas bubbles or solid particles on the surface of the electrodes. Therefore, a slightly ascending pipeline is advisable, preferably with a deaerating possibility at its highest position.

The fitting position should be chosen in such a way that a good readability and handling of the operating unit is guaranteed.

The pipelines within the inlet and outlet pipe sections must not show any unevenness, e.g. welding beads.

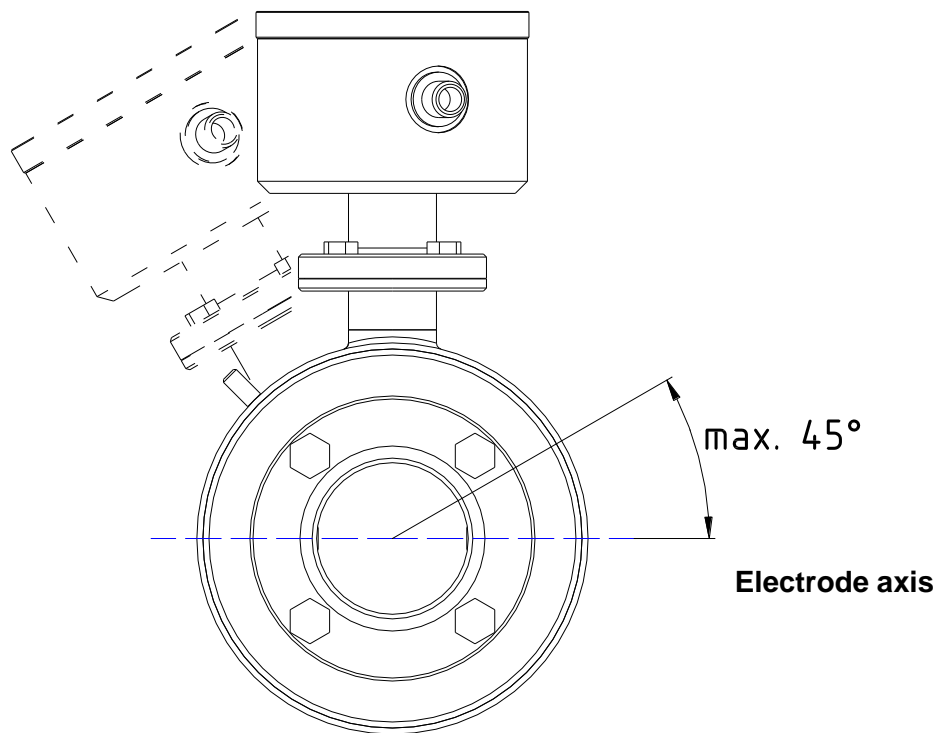

Suggestions for installation

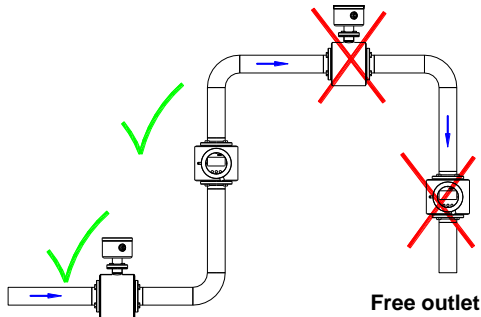

Wrong

At the highest point of the pipeline. Gas bubbles accumulate in the transmitter. → Faulty measurement!

Wrong

Descending pipe:

At the end of the conveyance of the metered product the pipe runs empty. → Measuring errors!

Correct

Preferred mounting position:

Rising pipeline and horizontal pipe section before an ascending pipeline

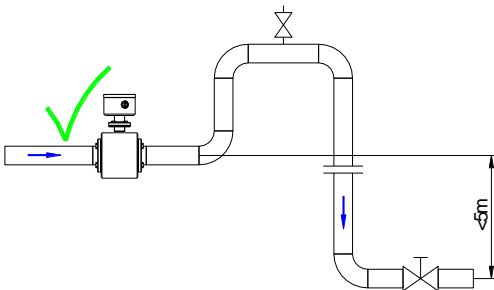

Descending pipelines of a length of more than 5 m have to be equipped with a deaeration valve after the flow meter.

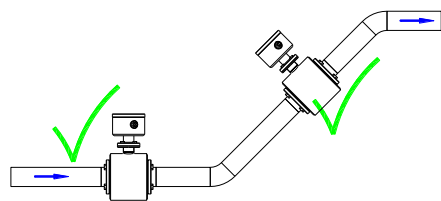

Correct

In case of a horizontal pipe conduct the mounting position is placed in slowly increasing sections of the pipe.

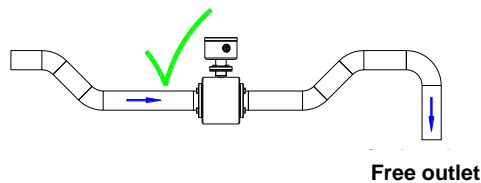

Correct

Provide a culvert for free inlet or outlet. The transmitter is permanently filled with liquid as demanded.

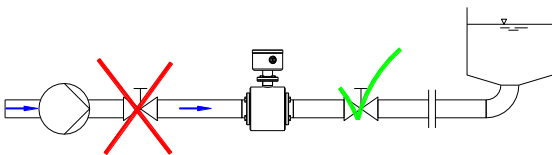

Long lines **after** the flow meter always have to be equipped with a shut-off device. If it is placed before the flow meter, a vacuum will be caused in the metering pipe by the big kinetic energy in the liquid column when shutting off. This can damage the lining of the tube!

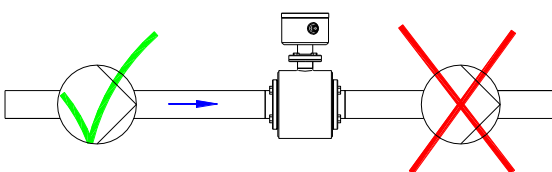

Do not place the flow meter on the suction side of the pump! → **Danger of negative pressure!**

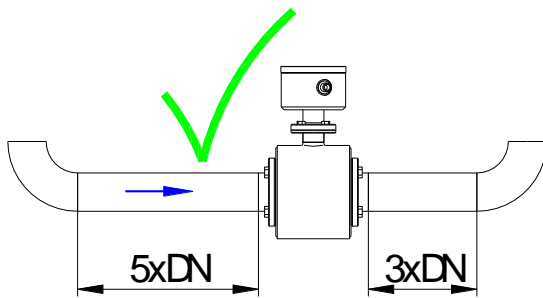

Keep the recommended inlet and outlet sections!

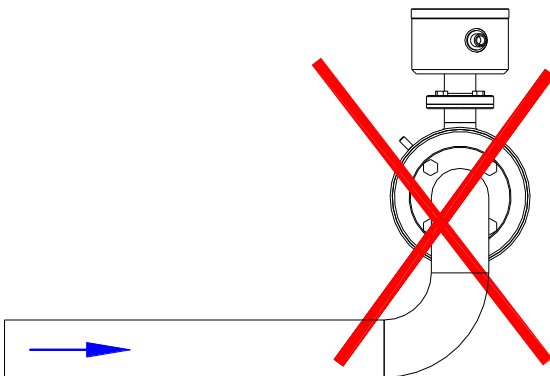

Avoid curvatures of space before the flow meter!

Installation requirements for 3-A sanitary applications

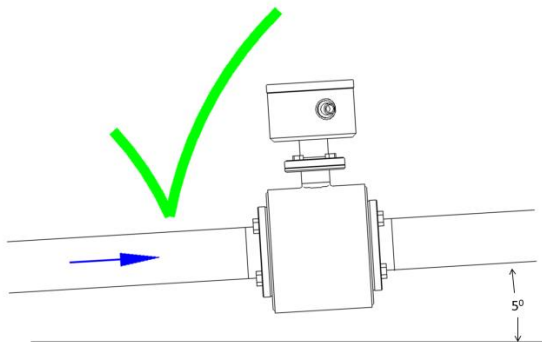

Correct

In horizontal applications a slope of greater than 5 degrees is required to ensure that proper drainage occurs in the pipeline.

4.1.4. Inlet and outlet pipe sections

For the installation of electromagnetic transmitters DIN 1944 recommends an inlet pipe section of 5 x DN and, accordingly, an outlet pipe section of 3 x DN in case of an undisturbed flow. For an irregular flow (e.g. distorted rotational flow profile) the inlet and outlet pipe sections have to be extended accordingly or a rectifying device for the flow has to be installed in order to guarantee the specified measuring accuracy.

4.1.5. Conductivity conditions

The liquid to be measured has to show a minimum conductivity of $\geq 5 \mu\text{S/cm}$.
Demineralsised water requires a conductivity of $\geq 20 \mu\text{S/cm}$.

A count suppressor for empty meter tubes belongs to the standard equipment of the converter. That function will have to be switched off at conductivities below $50 \mu\text{S/cm}$ ('Pipe Detect' off).

In case of low conductivities it is recommended to carry out a calibration under operating conditions.

4.1.6. Interference fields

Straight at the transmitter masses of iron or strong permanent or electromagnetic fields must absolutely not exist, as they could influence the defined exciting magnetic field, thus falsifying the signal.

4.1.7. Earthing/grounding conditions

A perfect earthing/grounding of the transmitter is an essential requirement for a reliable and accurate measurement.

“Inductive measuring method” means that the metered liquid itself acts as an electric conductor, i.e. a correct and careful earthing/grounding ensures that no additional potentials will falsify the extremely low metering signal.

For that reason, the earthing/grounding resistance has to be definitely smaller than 10 Ω . The earth/ground wire used must not transfer any interference voltages, i.e. no other electric devices must be connected to that line.

If in case of a plastic pipe system no equipotential bonding is available between the inlet and outlet sides, it will be necessary to take some appropriate measures for a potential equalisation.

The transmitter has to be earthed/grounded as shown in this picture:

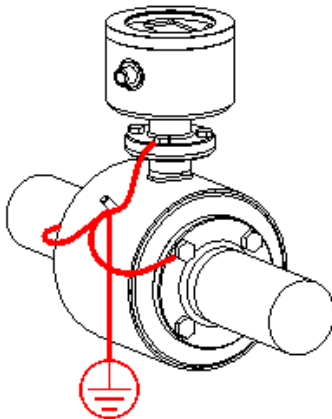

4.1.8. Meter tube lining

A damaged PFA lining can cause faulty measurements or even a failure of the flow meter.

Choose the place of installation in such a way that no negative pressure can be caused, even not when the pump is switched off. An installation at the highest point of the pipeline has to be avoided!

4.2. Flow direction

The FMQ measures the flows in both flow directions in principle. The main flow direction is marked on the converter by means of an arrow:

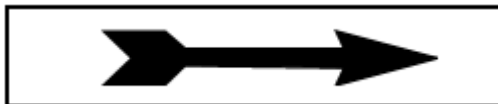

In the standard setting the digital outputs emit the volume pulses independently of the flow direction. Negative flow rates and quantities are displayed with a MINUS sign. On the condition that the inlet and outlet conditions are kept, the accuracy of the measurement in both directions is only slightly different.

4.3. Conditions required for the converter



Caution

Please observe the following points for the locating place to protect the converter against damage:

- The limit values for the ambient temperature have to be kept.
- Fasten the field housing from mechanical strain!
- No moisture may enter the field housing through the cable gland.
- The converter has to be installed at a place which is free from vibration to a large extent.
- The covers have to be closed.
- The housing may not be permanently subject to dripping water.

Apart from that, please ensure that the housing can be easily opened for service purposes. The converter has to be installed in such a way that perfect reading and operation of the operating unit is guaranteed!

4.4. Alignment of the converter

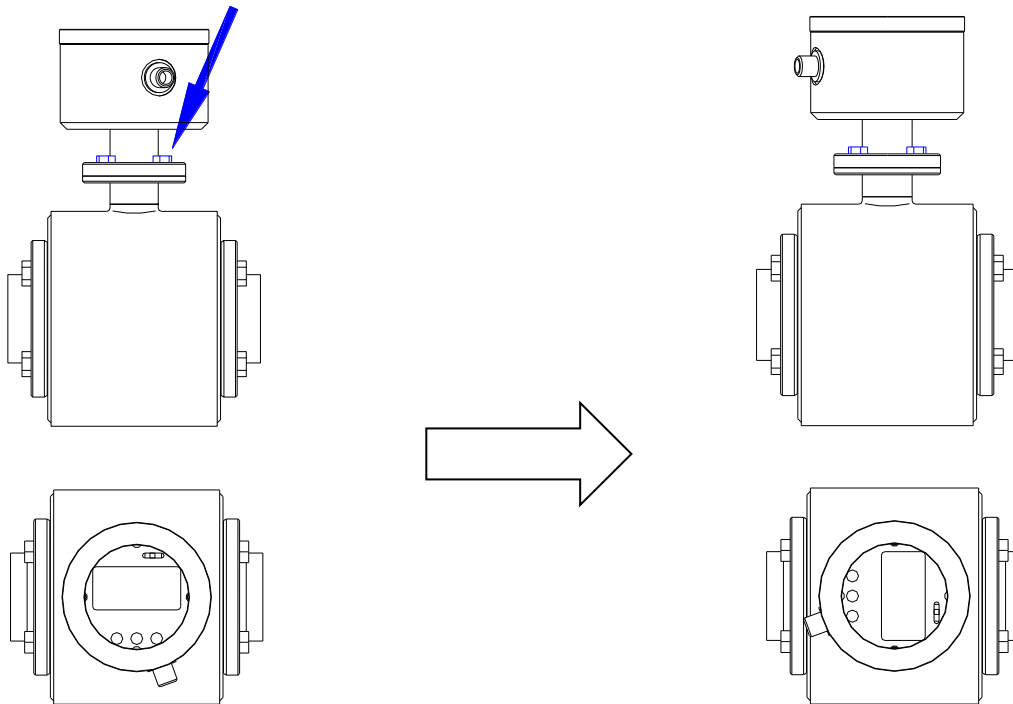

1. Loosen the 4 screws crosswise (**Do not remove them!**)!
2. Turn the converter into the desired direction (180° max. to the left or right)!
3. Tighten the 4 screws crosswise!

4.5. Welding work



Caution

Welding work involves the risk of destruction for the electronic measuring equipment!

Pay attention to the fact that the earthing/grounding of the welding set is not carried out through the transmitter or the converter!

The welding seams at pipelines have to be executed by means of suitable work equipment and filler materials and after a careful preparation of the pipe ends in such a way that a perfect welding effect is guaranteed and that internal stresses (e.g. welding distortion) is kept limited to the absolute minimum.

Before welding work is started, the FMQ will have to be removed from the pipeline:

1. Fasten the FMQ transmitter by some welding point inside the pipeline!
2. Unscrew the screws at the process connection flange! Remove the transmitter including the seal from the pipeline!
3. Weld the process connection into the pipeline!
4. Reinstall the transmitter into the pipeline! Pay attention to cleanliness and the correct position of the seal!

4.6. Cover



Unless the cover is closed,
the flow meter will *not* be protected from
moisture!



If the cover is closed (finger-tight),
the flow meter will be protected from moisture!

The FMQ is only protected from moisture, if the covers are correctly screwed down.
A properly screwed down cover is recognized by the fact that the metallic stop is reached.

5. Installation

Only persons disposing of the necessary expert knowledge and authorization of the user are allowed to carry out the installation work. The qualified personnel have to have read and fully understood this instruction manual and follow all instructions given therein.

The state of the art is always a decisive criterion for the execution of the installation.

The following points should be taken into account after completion of the installation work:

- It has to be checked whether all external supply connections really meet the requirements specified in the technical data of the flow meter (e.g. pressure, temperature, etc.).
- The pipelines have to be flushed before the production is started.
- All external supply joints have to be checked for their safe, leak-proof, and nearly stress-free connection to the transmitter.
- The media supplied have to be cautiously adjusted to their required working pressure.
- Occurring leaks have to be removed immediately.
- All electrical lines have to be separated from the flow meter before welding work is started at the pipeline.

The electric wiring of the voltage supply and the inputs and outputs of the control circuits has to be carried out according to the wiring diagram.

In this respect the state of the art is relevant, too.

5.1. Installation instructions for the transmitter



Caution

Pay attention to the fact that the threaded fittings, clamps, or flanges are perfectly tightened! Otherwise, hot or caustic solutions or gasses could escape through gaps and clearances.

- Escaping liquids can cause slip hazard.
- Escaping liquids have to be mopped up immediately and disposed of safely.
- If combustible liquids come out, they could cause an explosion hazardous area around that place which has to be marked accordingly.

If the transmitter is connected to existing process lines, those lines have to be unpressurized and free from product.

Do not omit to insert the seals into the screwed counterfittings!

In case of leaking pipe connections you should in any rate check the seals. Never squeeze the seal when tightening the threaded pipe connections!

5.2. Installation instructions for the converter

In case of the compact design, the converter is arranged on the transmitter, i.e. it is located straight inside the pipeline.

For the separated design the field housing is typically delivered for wall mounting.

Cable glands always have to point downwards.

When installing the flow meter, pay special attention to the fact that no moisture by drip or splash water can get onto the electronic board.

Metal particles, such as scobs or residues of the shielding braid, have to be removed from the boards before the electric power supply is switched on.

See to it that the pipelines are supported in such a way that no forces and moments are exerted on the measuring device.



Caution

The display must not be exposed to direct insolation!

5.2.1. Installation of the electrical power supply



Caution

The following safety precautions have to be followed for the execution of the electrical installation work:

- The supplying system has to guarantee an overvoltage protection for the device according to category II.
- For reason of EMC (according to definition EN 50 081-2) the FMQ may be used in industrial areas only.

5.2.2 DC Input

M12 Connection / Communication selection	Pin 1	Pin 2	Pin 3	Pin 4	Pin 5
X and M12 (EU) 0 and S (NA)	+24 V DC	4...20 mA	0 V DC	Pulse output	N/A
K	+24 V DC	4...20 mA	0 V DC	C/Q - IO-Link	N/A
M	+24 V DC	4...20 mA	0 V DC	Pulse output	Switch input
L	+24 V DC	4...20 mA	0 V DC	C/Q - IO-Link	Switch input

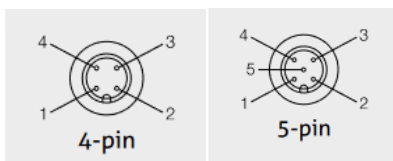

5.2.3 Optional Digital Input

Digital input	
Auxiliary voltage	9...32 V
Input resistance	< 3.2 kΩ
Input frequency	1kHz max.
Function	Voltage ON → reset counter

5.2.4 Digital output

Digital output	
Output current	20 mA max.
Output frequency	1kHz max.

The following figure shows the basic wiring diagram of the pulse outputs. The outputs switch off in case of overload. By removal of the overload the outputs will be reactivated after a few seconds.

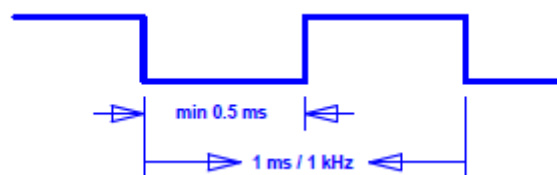

Output signal at 1 kHz

The pulse duty cycle depends on the load, too. An electronic counter has to have an input frequency of at least 5 kHz.

5.2.5 Analog output - current output

Analog output	
Hardware mode	Active
Operating mode	4...20 mA
Load	500 Ω max.
Error	< 0.2 %

The analog output works in both flow directions!

5.3 Display

The standard version (converter without display) can be retrofitted with a display, if desired. The following parts are required for such a retrofit:

Item	Description
1	Display
2	Display cable
3	Cover with transparent pane
4	4x M3x10

Conversion instructions:

1. Unscrew the cover!
2. Connect the display and the converter (plug XD1) by the cable!



3. Fix the display by the M3x10 screws!



4. Close the housing by the cover (with the transparent pane)!

6 Commissioning

6.1 General information

The measuring device may only be operated by trained persons who have got the necessary authorization from the user of the device. The operators have to be familiar with the process sequence, able to recognize possible dangers, and in a position to take the necessary steps for the removal of accident risks.

Safety measures for the commissioning work



Caution

Both an orderly performed installation and a correct electrical connection are absolute prerequisites for the commissioning work!

Pay attention to the following points upon the initial start-up of the flow meter:

- Close the housings of transmitter and converter!
 - Personal injury by electric shock can be caused, if the electric lines are touched.
 - Instrument damage can be caused by moisture or metal parts on the electronic unit.
- Ensure that all threaded joints at the measuring instrument and in the direct vicinity are really tight!
- Any possibly existing dehydrating agents have to be removed from the housings before the commissioning is started!

6.2 Advice for starting-up the FMQ

1. First of all the measuring device has to be installed into the pipeline!

- The auxiliary energy has to be switched off.
- The auxiliary energy has to correspond to the specification on the nameplate.
- The pin assignment has to correspond to the wiring diagram.
- The temperature limits have to be kept.
- Both the transmitter and the converter have to be correctly earthed/grounded.
- The converter has to be installed at a place which is free from vibration to a large extent.
- The housing cover has to be closed before the auxiliary energy is switched on.
- The flow range adjusts itself automatically.
- After the electrical start-up a **"ZERO adjust"** should be carried out by means of the typical liquid to be measured (full meter tube and **no** flow!).

2. How to put into operation the analog output?

- Dependent on the flow rate, the analog output produces a current of 0/4...20 mA.

With display only (option):

- The allocation of the flow range "20mA = Q_{max} " for the analog output of the FMQ is set by the respective parameters.
- The flow simulation can be used for a functional check.

3. Which other conditions should be taken into consideration?

- Too low product conductivity?
Below 50 $\mu\text{S/cm}$, the internal empty-pipe detection has to be switched off by the respective parameter setting.
- Is the analog output too unsteady?
A time constant TP3 can be set by the relevant parameters.

6.3 Basic settings upon delivery

At the factory the electromagnetic flow meter is adjusted and delivered with a standard parameter setting.

6.3.1 System structure and operating elements

The electronic part is permanently installed in the FMQ converter. The electrical connection (M12 plug) is on the side of the device. The front is equipped with a satin-glass pane with a 3-coloured background LED-lighting. The colour shows the current status of the device. In case of the display version the display with three optical buttons is arranged on the front side. The display can be used to read device information and to change device settings.

6.4. Zero point adjustment (“ZERO adjust”)

Upon the first start-up of the flow meter it is recommendable to carry out a **zero point adjustment** (“ZERO adjust”) for an adaptation of the flow meter to the conditions prevailing in situ.

ATTENTION! The following conditions have to be observed and kept for a **ZERO adjust**:

- (1) The device has to have reached its working temperature, i.e. it should have been switched on at least 5 minutes before.
- (2) The transmitter has to be clearly filled with the typical liquid free of gas.
- (3) **No flow** is allowed to be available. The liquid has to be resting.
- (4) **No flow** is allowed to occur during the whole “ZERO adjust” measurement.

6.5 Metering with an empty meter tube

Metrologically perfect flow measurements are only possible, if the meter tube is evidently filled with liquid.

In order to avoid an undefined counting in case of an empty meter tube, the FMQ offers an internal possibility for suppression:

6.5.1 “EMPTY pipe detection”

The FMQ is equipped with a special “EMPTY pipe detection” (“**pipe detect**”). The setting is made via the parameters. Usually, the EMPTY pipe detection is switched on, i.e. an undefined count will be suppressed in case of an empty meter tube.

At the following situations, the internal EMPTY pipe detection has to be switched off by the parameter setting:

- At a product conductivity of less than 50 μ S/cm.
- At a heavily pulsating flow (piston, membrane or hose pumps).

6.6 External reset of counter (use of digital input)

For the external reset of the counter can be done by using the digital input IN1. Activation can be done by having a 9V ... 24V DC signal on PIN 5 of the 5-PIN M12 plug. This function has to be switched on by the parameter settings.

6.7 Status indication

In the standard version the status of the device is displayed by a 3-coloured LED through the satin-glass pane in the cover.

LED colour	Blinking code	Meaning
Blue	Increasing and decreasing	The device is ready for operation and no flow rate is available.
Blue	1:1	Zero-Adjust measurement is carried out
Blue	1:10	Empty pipe is detected
Green	--	Flow rate is measured
Green	1:1	Q_{max} exceeded ($Q > 120\%$)
Red	1:1	Malfunction

6.8 Optical operating elements (display version)

The display unit is provided with optical keys for the operation which enable the FMQ to be operated through the closed cover.



Important information

The converter calibrates the optical keys in regular intervals. Such a calibration can only function perfectly, if the optical keys are not covered. After removal or reassembly of the cover the optical keys are not allowed to be touched for approx. 20 seconds. After that time the optical keys will be functioning again.

During the operation or during an input the calibration will be ineffective.



Caution

The operation is only permitted to be carried out while the front cover is closed. Otherwise, the operating unit, the display, and the optical keys could be damaged. Dirty fingers (e.g. by oils or fats) can cause faulty functions of the optical keys.

7 Operation

Only persons disposing of the necessary expert knowledge and authorization of the user are allowed to operate the FMQ.

During normal measurements the operation is restricted to the zero reset of the volume registers. The keypad is dynamically controlled by the image navigator.

The operating unit can be adapted to the fitting position of the flow meter in steps of 90°, thus enabling a perfect reading and handling of the operating unit.

The display is illuminated by a permanently switched on background lighting which permits a stressfree reading and which is switched off after 5 minutes. It is only restarted after one of the three optical keys had been actuated.





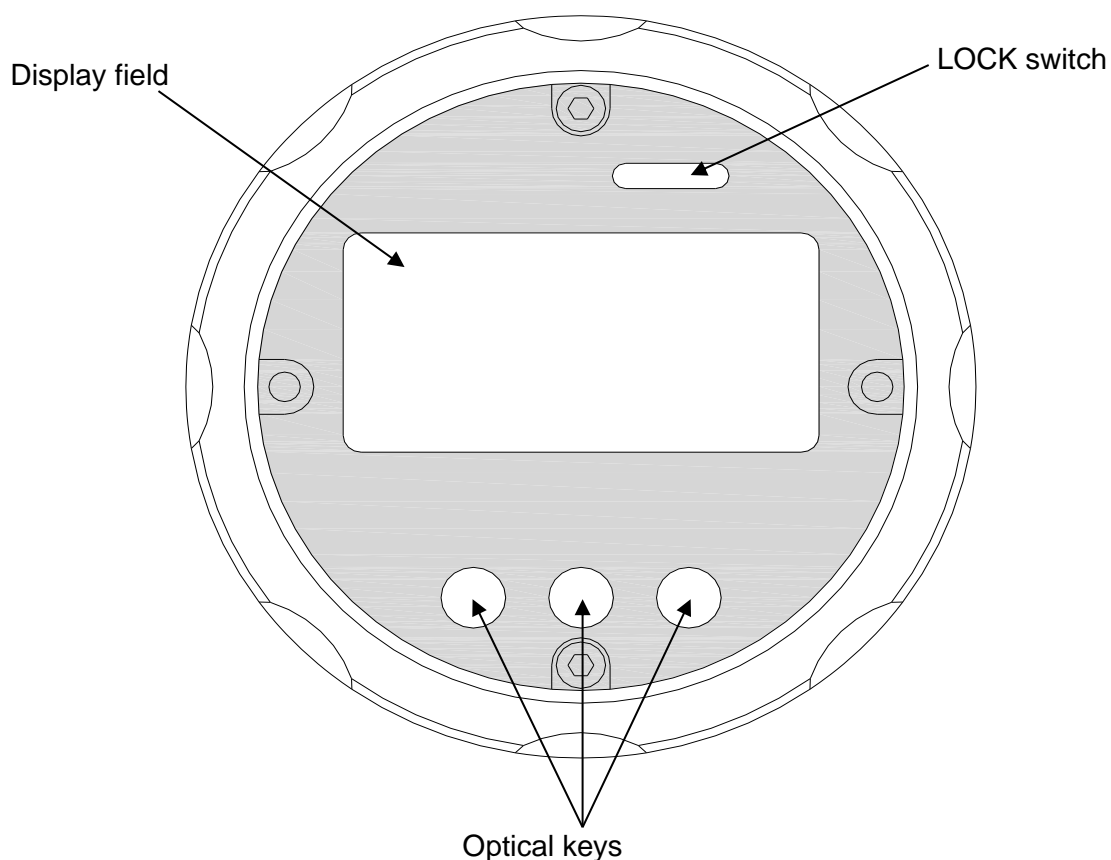

The optical keys can be deactivated by means of the LOCK switch. See the chapter "LOCK switch".

Elements of the operating unit:





7.1 Basic keypad functions

The keypad consists of 3 optical keys. The functions of the keys are indicated by symbols and texts. The function of the keypad is dynamically controlled by the image navigator:

	Changing the main image level
	Returning to the main image level or to the measuring image
	Changing to the next sub-image
	Resetting the volume to zero
	Changing the setting parameters, e.g. to change the pulse mode
	Changing the numerical parameters, e.g. low flow quantity



Key functions for the value input (numerical parameter):

	Next input position
	Changes the input position
	ENTER, terminates the numeric input

7.2 Image navigator

The display is divided into **main images** and **sub-images**. Sub-images are allocated to each main image level.

To permit a quick overview of the parameterization the main image shows the most important parameters and settings for the adjustment of the device.

The basic setting of the image navigator is the measured value level where the volume and the flow rate are displayed. A timeout function makes sure that the FMQ always returns to that image level. The image navigator is controlled by the keys ,  and .

Basic functions of the image navigator:

- Reading the measured values
- Selecting the different functions
- Parameterization
- Service display

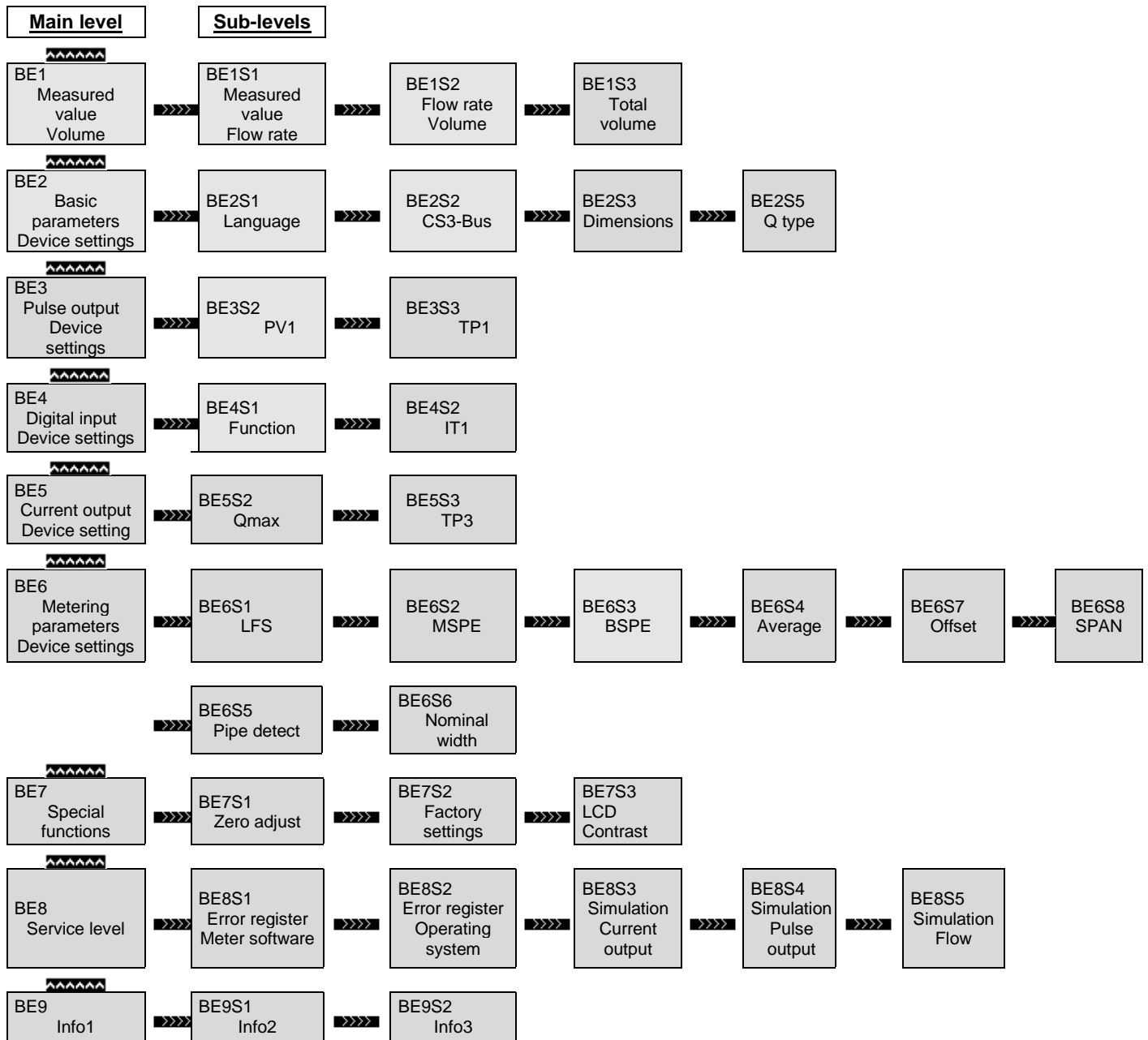

7.3.1 Zero reset of the volume counter

The main image shows the volume. This image is permanently shown while the flow meter is switched on. "Zero reset" is a function which can be carried out without any additional activation.

For a zero reset, please keep the **ZERO** key depressed for about 5 seconds.

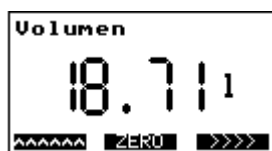

7.3.2 How to delete malfunction messages

Possible malfunction messages are deleted by resetting the volume counters.

7.3.3 Parameter change

There are two kinds of parameters, in principle:

- **Setting parameters**, e.g. pulse mode
- **Numerical parameters**, e.g. TP1

A setting parameter is changed by the **++** key. The **change** key opens an input field for the entry of the numerical parameter selected.

Parameter change is only possible, if it has been unlocked before. Unless it is unlocked, the input of the unlock code is requested automatically.

How to change a numerical parameter:

Press the **change** key and an input field will appear. The instantaneous value is shown inversely, whereas the changeable position is normally shown.

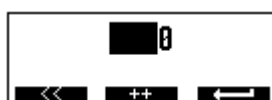

The **++** key changes the digit in the input position. The next left-hand input position is selected by the **<<** key. If the numerical parameter is set to the desired value, the input is terminated and accepted by the **←** key.

How to change a setting parameter:

The procedure is described by means of the example of the Dimension".



The current "Dimension" is set to "Litres". The next "Dimension" is selected and/or adjusted by means of the **++** key.

The next "Dimension" appears on the display.

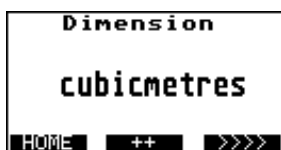

7.3.4 How to release a parameter change:

If a parameter has to be changed and the parameter change is not released, the display will request the input of the code number.



Input the code number as described in item 7.2.3. If the correct code number has been input, the display will show the message "Parameter input unlocked". In case of a wrong code number the display will show "parameter input blocked".

Code number for the parameter change: **222**.

7.3.5 How to release the service functions:

Some service functions have to be released by a code number. Unless they are released, the display will show a request to input the code number.



Input the code number as described in item 7.2.3. If the correct code number has been input, the display will show the message "Service level unlocked". In case of a wrong code number the display will show "Service level blocked".

Code number for the service level: **333**.

7.4 Image level: Measured values

The image level consists of the pictures BE1, BE1S1, BE1S2, and BE1S3.

7.4.1 Measured value: Volume



A 4-seconds long activation of the **ZERO** key will reset the volume to "0".
 The size of the digits is controlled by the size of the measured value.
 The volume indication is the central image that is always shown after a reset.
 The volume will be reset automatically, if the value exceeds 1.000.000.000, falls below -100.000.000 or the digital input for external resetting the conter is active.

7.4.2 Measured value: Flow rate



The size of the digits depends on the size of the measured value.

7.4.3 Measured value: Flow rate and volume

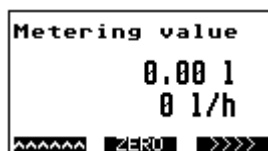

Joint indication of volume and flow rate
 The volume will be reset automatically, if the value exceeds 1.000.000.000, falls below -100.000.000 or the digital input for external resetting the conter is.

7.4.4 Measured value: Total quantity

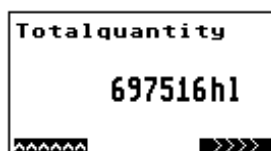

The totalizer indicates the total sum of the quantities passed through the flow meter.
 The totalizer cannot be reset to zero.

7.4.5 Error message: Transmitter not connected



This error message will be displayed, if the transmitter is not connected. The cause of the error is the missing coil connection.

7.5 Image level: Base parameters

The image level consists of the following pictures: BE2, BE2S1, BE2S2, BE2S3, BE2S4 and BE2S5.



This image level offers the possibility to make some basic settings. The main image shows the current device setting.

7.5.1 Language



Use the key **++** to change the language. You could be asked in advance to enter the unlock code.

7.5.2 CS3Bus address



The CS3-Bus address can be changed by means of the key **++**. You could be asked in advance to enter the unlock code.

7.5.3 Dimension



The **++** key can be used for changing the dimension (unit) of the measured value. You could be asked in advance to enter the unlock code. In case of changing the dimension the single and total amounts will be set back on zero.

Abbreviation	Unit	m dim
l	Litres	1
m ³	Cubic metres	0.001
hl	Hectolitres	0.01
ml	Millilitres	1000
gal	U.S. gallons	0.2642
gal	Gallons (CDN)	0.21997
gal	Imp. Gallons	0.21997
lb	lb raw milk	2.27189
bbl	beer barrels	0.00611
dm ³	Cubic decimetres	1

7.5.4 QTYP



The key **++** can be used for setting the unit of measure for the flow rate indication. Possibly the input of the unlock code is requested before. Two different settings are possible: l/h or l/min.

7.6 Image level: Pulse output

The image level consists of the pictures: BE3, BE3S1, BE3S2, and BE3S3.



This image level serves for the setting of the pulse output. The main image shows the current device setting.

7.6.1 PV1

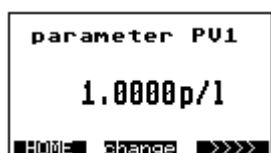

The pulse value PV1 can be changed by the **change** key. You could be asked in advance to enter the unlock code.

7.6.2 TP1



Use the key **change** to change the pulse length of TP1 to ms. TP1 is valid for Mode1 only. The value of 0 ms sets the pulse-to-pause ratio to 1:1. You could be asked in advance to enter the unlock code.

7.6.3 IT1



Use the key **ändern** to change IT1 into ms. IT1 determines how long the signal for the input will have to be available to activate the selected function. You could be asked in advance to enter the unlock code.

7.7 Image level: Digital input

This image level consists of the pictures BE4, BE4S1, BE4S2.



The settings for the digital input are made on this image level. The main image shows the current device setting.

7.7.1 Function: Digital input

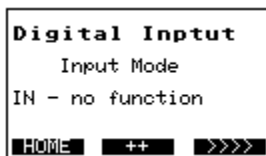

The function of the digital input can be selected by means of key **++**. The input can be set to:

- No function
- Count interruption
- Zero setting

The key **++** only appears if the unlock code has been activated before. You might be prompted to first input an unlock code.

7.7.2 IT1



The **change** key can be used to change IT1 to ms. IT1 determines how long the signal will have to be available for the input to permit the selected function to become active. You might be prompted to first input an unlock code.

7.8 Image level: Current output

This image level consists of the pictures BE5, BE5S2, and BE5S3.



On this image level the settings for the current output are made. The main image shows the current setting of the device.

7.8.1 Qmax



The key **change** can be activated for changing the Qmax value for the current output. Qmax is the value for 20 mA. You could be asked in advance to enter the unlock code.

7.8.2 TP3

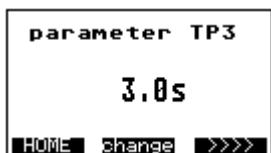

By means of the key **change** you can change the time delay TP3. The current output is attenuated by this time. You could be asked in advance to enter the unlock code.

7.9 Image level: Metering parameters

The image level consists of the following pictures: BE6, BE6S1, BE6S2, BE6S3, BE6S4, and BE6S5.



The settings for the measurement are made on this image level. The main image partially shows the current device settings.

7.9.1 LFS

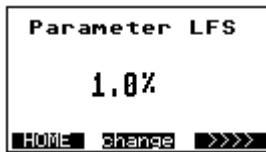

The key **change** can be used to change the low-flow suppression LFS in %. The low-flow volume is calculated from the Qmax value.
You could be asked in advance to enter the unlock code.

7.9.2 MSPE

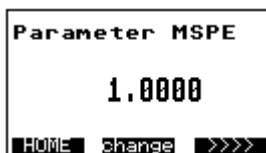

By means of the key **change** you can change the dimensionless factor MSPE.
You could be asked in advance to enter the unlock code.

7.9.3 BSPE

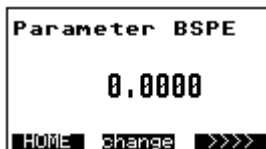

Use the key **change** for changing the dimensionless offset BSPE.
You could be asked in advance to enter the unlock code.

7.9.4 Average



The average value can be changed by means of the key **change**.
You could be asked in advance to enter the unlock code.

7.9.5 Offset

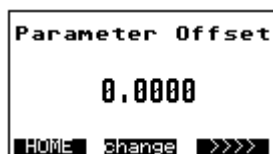

Press the key **change** for changing the Offset value.
The Offset is a calibration value of the sensor which is normally not changed!
 Code number for the offset level: **145**.

7.9.6 SPAN

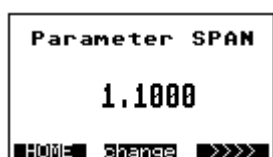

The SPAN value can be changed by the aid of the **change** key.
The SPAN value is a calibration value of the sensor which is normally not changed!
 Code number for the SPAN level: **145**.

7.9.7 Pipe Detect (recognition of an empty meter tube)

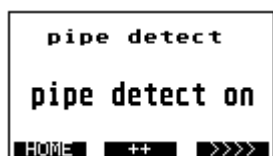

The empty pipe detection can be switched on and off by means of the **++** key.
 You could be asked in advance to enter the unlock code.

7.9.8 Nominal width

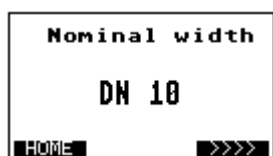

The display shows the nominal width of the transmitter.
 Code number for the Nominal width: **222**

7.10 Image level: Special functions

This image level consists of the pictures BE7, BE7S1, BE7S2.



Special functions can be carried out on this image level.

7.10.1 Zero adjust

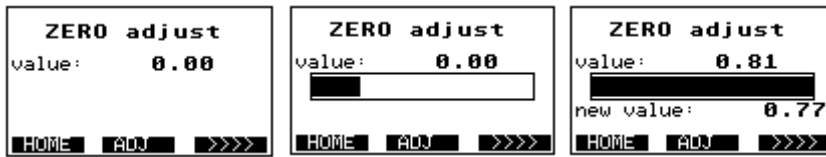

The “ZERO adjust” measurement is activated if the **ADJ** key is depressed for a period of 1.5 seconds. The top line of the display shows the current ZERO value. The course of the bargraph shows the progress of the measurement. The measurement is finished when the bargraph is completely filled. The new ZERO value is displayed below the bargraph and taken over.

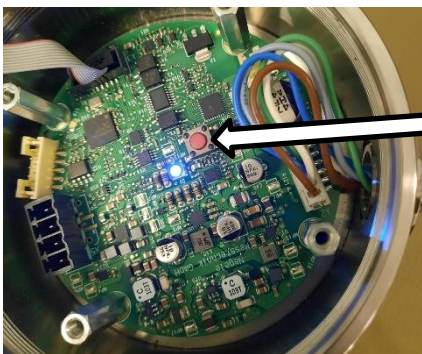

The ZERO adjust measurement can be alternatively started by means of the red ZERO adjust key (see the picture). The LED is blinking in blue colour as long as the function is active.



Prerequisite:

The meter tube has to be filled up with the liquid to be measured.
 No flow rate is allowed to be available, the liquid rests.
 Unless the prerequisites are observed, a faulty ZERO value will be determined and the FMQ will not be able work correctly.

Important information

7.10.2 Factory settings



All parameters are reset to the factory settings. After the execution of the function, the image navigator will change back to the image of item 7.9. You could be asked in advance to enter the unlock code.

7.10.3 LCD contrast



The LCD contrast level permits an optimum setting of the display contrast.

7.11 Image level: Service level

The image level consists of the pictures BE8, BE8S1, BE8S2, BE8S3, and BE8S4, BE8S5.

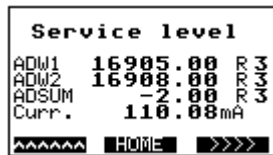

Only service values are displayed and service functions are performed on this service level.

7.11.1 Error register: Metering

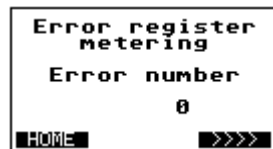

This image shows the error numbers of the measurement.
The error number is reset while the flow meter is set back to zero.

7.11.2 Error register: Operating system

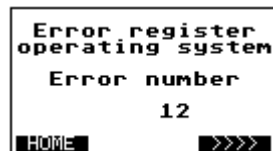

This image shows the error numbers of the operating system.

7.11.3 Simulation of the current output



The simulation can be used to check the cable connection or to adjust an analog instrument. The first value 20 mA is set to 100 % by means of the key **++**. Another activation of the key **++** will set 12 mA, 50 %. After that the key **++** is used for the setting of the value of 4 mA to 0 %. The simulated current value is determined by the current mode, see item 7.7.1. If the setting is 0...20 mA, the simulated values are 20 mA, 10 mA, and 0 mA.

You could be asked in advance to enter the unlock code.

7.11.4 Simulation of the pulse outputs



This simulation can be used for checking a cable connection or a counting instrument or even a connected controller. According to the output mode, the number of pulses to be simulated is shown in display lines 6 and 7. The simulation is started by the key **++** and a bargraph is displayed. The simulation is finished when the bargraph is completely filled. Then the bargraph is erased. You could be asked in advance to enter the unlock code.

7.11.5 Simulation of the flow rate



This function can simulate the complete metrological functionality of the FMQ converter, i.e. the pulse outputs and the current output behave like in the normal operation. This function is suitable for the “dry” commissioning of a system or of system sections. The **++** key starts the function. The flow reads 0 l/h. Each further activation of the **++** key increases the flow in steps of 10% of Qmax. The function stops running as soon as the maximum value is reached. You could be asked in advance to enter the unlock code.

7.12 Image level: Info

The image level consists of the pictures BE9, BE9S1, BE9S2. This image level shows some general information which e.g. serves for the identification of the device.

7.12.1 Info1



The Info1 image shows the software versions and the date of the recent software download.

7.12.2 Info2



The Info2 image shows the hardware version and the board number of the main board.

7.12.3 Info3



The image Info3 shows whether the device is equipped with a parameter box. That box includes the stored parameters of the transmitter and customer-specific settings. In case of an exchange of the converter, the parameters will be transmitted with this box to the new converter. Unless the device is equipped with a parameter box (standard scope of supply), the text "no parameter box" will be displayed. If the text "SENSORBOX" is displayed, the new box is available particularly for the FMQ.

7.13 LOCK switch

From the software version V2.02 it is possible to deactivate the optical keys by means of the LOCK switch (left-hand switch position) in order to avoid operating errors. The image level (BE1, BE1S1, BE1S2 or BE1S3) is shown in the LOCK position, depending on the image which was displayed upon the actuation of the LOCK switch. If the display is on another image level while the LOCK switch is actuated, BE1 will be automatically displayed. The LOCK status indication appears above the optical keys.



means that the LOCK switch is active.

To terminate the LOCK mode, the switch has to be pushed into its right-hand position.



The optical keys are blocked.



The optical keys are released.

8 Parameterization

At the factory the FMQ is provided with standard parameters (factory settings).



Important information

Only trained persons authorized by the user of the flow meter are allowed to set and/or change parameters. The persons concerned have to be familiar with the process sequence. They have to be able to recognize possible risks and to take the necessary steps to eliminate dangers of accident.

Take into account that interventions into the parameters of the flow meter carried out while the production is running could lead to undefined reactions!

It is possible to modify the set parameters via the keypad and the display unit in principle.

The following table shows the factory settings and the limit values:

Parameters	Factory settings	Minimum value	Maximum value
CS3Bus address	32	32	64
PV1	1.0	0.0	Depending on output mode, dimension and Qmax
TP1	125 ms	0 ms	16000 ms
IT1	125 ms	0 ms	32000 ms
Qmax 100% for 20mA	Depending on the nominal width	1.0	999999.0
Q type	l/h	l/min	l/h
TP3	0.2 s	0.0 s	30.0 s
LFS = Low Flow Suppression	1.0 %	0.0 %	10.0 %
MSPE	1.0	-1000.0	+1000.0
BSPE	0.0	-1.0	+1.0
Average	16	1	128
Offset	See nameplate	-1.0	+1.0
SPAN	See nameplate	0.000001	1000.0
Pipe detect	Pipe detect	No pipe detect	Pipe detect

DN	Q max [l/h]	PV1 [pulse/l]
10	3000.0	1000.0
15	7000.0	100.0
25	18000.0	100.0
32	30000.0	100.0
40	45000.0	10.0
50	70000.0	10.0
65	120000.0	10.0
80	180000.0	10.0
100	280000.0	10.0

Table of the abbreviations used and their meaning:

Abbreviation	Function
PV1	Pulse value for IMP1
TP1	Pulse length for IMP1
IT1	Pulse length for IN1
Q max.	100% of the flow value for the current output
Q type	Setting of the flow unit
TP3	Time constant for the current output
Dimension	Unit of the volume
LFS	Low-flow suppression
MSPE	Calibration factor
BSPE	Calibration offset
Average	Filter of the flow signal (averaging)
Offset	Calibration value of the transmitter (Do not change!)
SPAN	Calibration value of the transmitter (Do not change!)
Pipe-Detect	Internal EMPTY pipe detection

8.1 Adjustments

The FMQ normally needs no adjustment.

Usually, the zero point adjustment (“**ZERO adjust**”) is carried out during the first commissioning only.

If, however, some deviations have to be compensated which were determined e.g. upon a comparison with a calibration vessel or a balance it is possible to make an adjustment via the factor “**m spe**”.

However, before you will start carrying out an adjustment you should have clarified the following questions in any rate:

- Are you sure that the reference standard (reference meter, balance, or calibrated vessel) does really deliver an exactly comparative value?
- Is the limitation of quantities always equal from measurement to measurement?
Take into account that differently emptying pipelines, a missing break-off edge for the liquid or temporary air occlusions will lead to faulty results during the measurement!
- Have the production paths been unlocked? Or are there any manual valves or sampling valves or any cross links possibly open?
- Is the liquid really conveyed during the measurement without any air or gas?
- Are the flow limits kept?
- Is the conductivity of the product within the required tolerance?

An adjustment is only reasonable if similar (reproducible) deviations have been ascertained during the comparative measurements.

8.1.1 Adjustment by calibration factor "m spe"

The adjustment by the calibration factor "m spe" can be set via the operating unit.

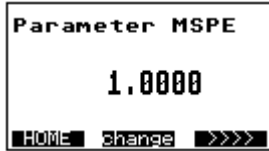

The standard value is set to 1.

The calibration factor is calculated by means of the following formula:

V_{ref} → Target volume (e.g. calibration vessel, balance, or the like)
 V_{dis} → FMQ display

An example is shown overleaf:

Example:

Deviation ΔF of +0.54% determined during a comparative measurement

Calibration vessel: $V_{ref} = 5000 \text{ L}$

Display: $V_{dis} = 5027 \text{ L}$

$$m \text{ spe} = \frac{5000}{5027} \cdot 1.0 = \underline{0.9946}$$

8.2 Measuring accuracy

Flow linearity: $\pm 0.5 \% \pm 2 \text{ mm/s}$ under reference conditions
Reproducibility: $\pm 0.1 \%$

Reference conditions for the determination of the measuring accuracy.

According to DIN EN 29104 and VDI/VDE 2641:

- Temperature of the measured product: $+20^{\circ}\text{C} \pm 10 \text{ K}$
- Ambient temperature: $+20^{\circ}\text{C} \pm 5 \text{ K}$
- Flow velocity: $0.5 - 12 \text{ m/s}$
- Product: Water (typical $500\mu\text{S/cm}$)
- Warm-up period: 30 minutes

Installation:

- Inlet pipe section $> 10 \times \text{DN}$
- Outlet pipe section $> 5 \times \text{DN}$
- Transmitter and converter are earthed/grounded.
- The transmitter is positioned in the centre of the pipeline.

9 Trouble-shooting

9.1 Error diagnosis

The FMQ is equipped with an integrated self-monitoring function. Malfunctions are recognized and automatically removed, if necessary.

9.1.1 Error diagnosis via the display

Displayed messages can support the troubleshooting in case of malfunction or faulty measurement. A distinction is made between error messages for the measurement or for the operating system. The messages are displayed on the service level:

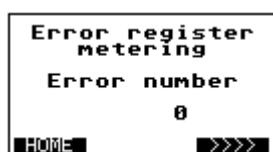

Error message for the measurement

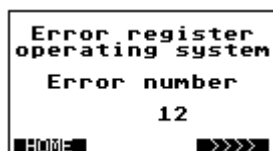

Error message for the operating system

Usually, all displayed messages are erased when the volume is reset to zero. In case of a permanent malfunction, however, the message will be reactivated over and over again.

9.1.2 Error list

Error No.:	Diagnosis	Remedial actions
905	Error found on the occasion of the internal examination of the quantity registers	a. The measuring result can be falsified due to the interference received. - Reset the message by resetting the individual quantity to zero! b. Check the whole installation for possible EMC interference sources; frequency converters have to be laid into separate cable channels! - Ensure good shielding and earthing/grounding for all devices! - Use the compact device version for critical installations!
963	Pulse output of the output channel IMP1 is exceeded.	- Adapt the flow rate! - Reduce the pulse value " pv1 "!
3031	Parameters of the transmitter cannot be saved.	Replace the converter!
3034	Calibration parameters of the electronics are faulty.	Replace the converter!
3035	Free parameters are faulty.	Replace the converter!
3036	Parameters of the transmitter are defective: Checksum error.	Replace the converter!
3037	Base parameters for the measurement are faulty: Checksum error.	Replace the converter!
3052	Meter parameters are faulty: Checksum error.	Replace the converter!
3063	Pulse value " pv1 " set for the counting output IMP1 is too high (>1000 Hz).	Reduce the pulse value " pv1 "!
3070	One of the calibration factors is set to zero.	Input the respective factor (e.g. SPAN)!
3083	The "ZERO adjust" measurement has not been accepted.	During the adjustment the flow rate was not "zero".

9.2 Typical effects or error sources

Disturbances or malfunctions can normally be recognized by the aid of the display unit only.

9.2.1 Flow without flow rate indication:

- (a) Is the conductivity higher than 5 $\mu\text{S}/\text{cm}$? Is the conductivity in case of demineralised water higher than 20 $\mu\text{S}/\text{cm}$?
- (b) Has the internal **EMPTY pipe detection** to be switched off?

Check whether the display shows "0 L/h" while the flow is running!

If "adsum 0" is displayed, the internal EMPTY pipe detection is active! This is the case, when:

- The conductivity of the liquid is below 50 $\mu\text{S}/\text{cm}$.
- The type of transmitter connected is smaller than DN 15.
- A heavily pulsating flow is available.

To make sure that the electronic part is working correctly, use the existing simulating function (hardware or software) for your further diagnosis of the digital or analog output!

9.2.2 No pulse transmission despite displayed flow

- (a) Is the polarity of the pulse counter correctly connected?
- (b) Check the parameters:
 - Is the pulse value too low? (Parameter setting)

Use the simulating function for your further diagnosis (hardware or software)!

9.2.3 No analog signal available

If no analog signal or a faulty analog signal is measured, the following checks are recommended to be carried out:

- a. First the connected measuring system (digital display, PLC or the like) has to be completely disconnected from the FMQ. The analog output signal has to be checked by the simulating function by the aid of an ammeter:
 - If the analog output is ZERO at a 50% simulation, the electronic part is defective, i.e. it will be necessary to replace the complete converter.
 - If the analog output remains constant at 20 mA, the internal "current mode" parameter could be wrong. Verification is possible by means of the operating unit.

- b. If the differences only occur after the disconnection of the external evaluating device, it should be checked:
 - If the burden of the whole current loop is higher than 500 Ω ?
(Observe the technical data sheets of the connected devices!)
 - If the input of the external evaluating device is erroneously designed as an "**active**" analog output?
Faults can especially occur upon a connection to a PLC due to the fact that it might both have an "**active**" and a "**passive**" configuration.

- c. If nonlinearities occur over the whole range from 0 - 100%, it should be checked:
 - Whether the burden of the whole current loop is higher than 500 Ω ?

9.2.4 Deviations of measured values

- a) Is there a time-related connection between the occurrence of the problem and some modifications to a system in the vicinity of the measuring device?
 - b) Does the deviation show more or less similar values or a constant shift or does it heavily scatter into the positive or negative direction?
 - c) Has something been repaired or replaced?
 - d) Does the deviation always occur at a certain point of time (e.g. on Mondays at the start of production, on the early shift, or the like) or at certain process steps?
 - e) If a display unit is connected, the measuring signals can be checked by means of the service data while the flow is static.
 - Change the display to the presentation of the measured values "adsum" which may be fluctuating between -300 ... +300 units at a maximum.
 - If you carry out several zero point measurements ("ZERO adjust"): The displayed value is not allowed to change by more than 10 units among the repeated measurements.
- Unless stability exists, the earthing/grounding of the transmitter will have to be checked. The wiring between transmitter and converter has to be shielded through the metal cable gland.
- f) The same verification has to be carried out with a full meter tube while the transmitter is removed as a whole. Any interfering influences by electrical disturbances or a leaking pipe system can be excluded in that status.
 - g) In case of moisture or other faults in the transmitter or converter it will be necessary to replace the measuring instrument by a new one.
 - h) Check the pipe path for by-pass lines or air occlusions (faulty seals).
 - i) Check the reference measuring methods or the test procedure (reference meter such as a balance):
 - Take into account the temperature compensation of the volume.
 - If different products are compared with the value of the balance, the conversion will have to be carried out by means of the density.

Or the same volume differences always occur e.g. at different quantities!

If so, possible reasons could be:

- A start and stop of the measurement while the meter tube is empty.
- An undefined limitation of quantity due to the absence of a break-off edge.
- An undefined dropping-off behaviour due to the absence of an appropriate draining sieve.

- j) Low conductivities or pulsating flow upon the use of the internal **EMPTY pipe detection**.

9.3 Error reset

Error messages and error outputs can be reset:

- (a) By a zero reset of the quantity counter
- (b) Automatically after a maximum period of 30 seconds, unless any further fault did occur.

9.4 Transmitter tests

9.4.1 Insulation test

The test is carried out by means of an ohmmeter. The meter tube of the transmitter has to be completely emptied before. The inner tube has to be absolutely dry, especially for measurements a) and b).

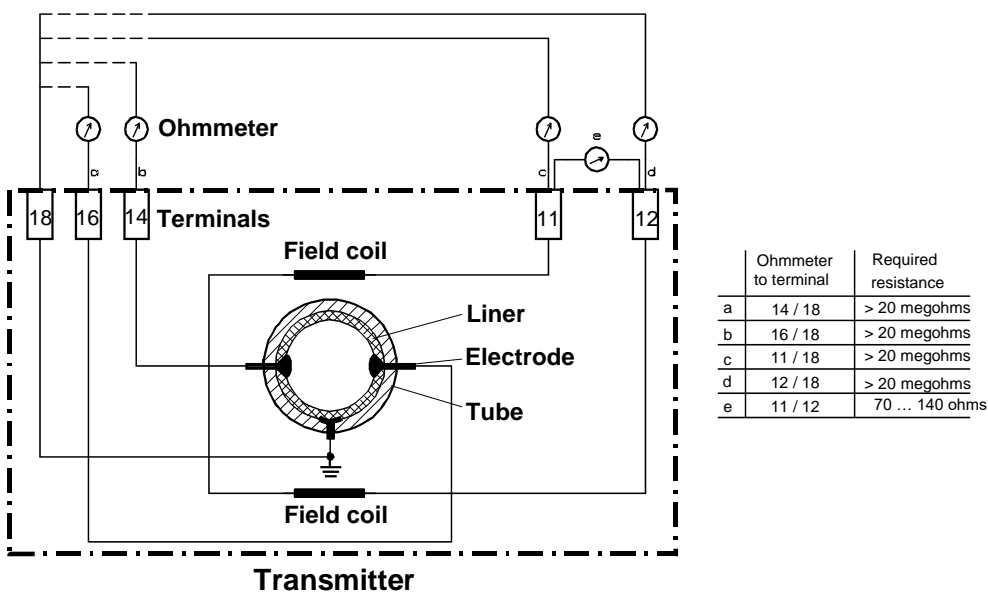

Figure: Insulation test

Visual check

The transmitter can be optically checked while being disassembled:

Reason	Action
Humidity in the connection housing	Dry the housing and perform an insulation test subsequently!
Damaged PFA liner	Replace the transmitter; check the seal!

Table: Visual check

10 Maintenance

10.1 Safety instructions for maintenance work

Maintenance and repair work must only be carried out by skilled and accordingly trained personnel entrusted with the required authorization from the user.

The persons concerned have to be familiar with the process sequence and be able to recognize possible dangers and to take all necessary steps to remove imminent risks of accidents.



First ensure your personal safety before you will start carrying out any service and maintenance work!

Caution

- Appropriate measures have to be taken to guarantee a safe stability (approved ladders, lifting platforms, safety harnesses, etc.).
- Applicable tools and personal protective measures are necessary.
- Before you start working at electrical or rotating equipment, make absolutely sure that the equipment concerned is disconnected from the power supply network! An unintended restart has to be avoided by suitable safety precautions (e.g. information signs or padlocks).
- Fittings and instruments and their contents can be hot! First permit them to cool down before you will start working at such parts!
- If fittings and instruments have to be removed from the pipe system, the whole pipe system has to be completely emptied, depressurized, and protected by some appropriate shut-off fittings.
- Rinse the pipe system with clear water before the disassembly of fittings or instruments in order to remove possible residuals of chemicals!

10.2 Routine maintenance

On normal operating conditions the flow meter type FMQ does not require any special maintenance work.

Nevertheless, we wish to give you some recommendations for maintenance steps:

Cleaning

Deposits in the meter tube or at the electrodes will cause measuring errors or malfunctions.

Thus, ensure a regular and careful cleaning of both the pipelines and the flow meter!

See to it during the external cleaning that e.g. no high-pressure steam-jets are directed to the housing parts!

In case of flow meters with integrated display the external cleaning temperature must not exceed 50 °C.

The pane of the operating unit should only be cleaned by means of clear water and a soft cloth.

The FMQ transmitter is suitable for CIP in principle.

Regarding the cleaning, disinfecting, and flushing agents and procedures we refer to the manufacturers and the relevant guidelines of the food processing industry.

Seals

The process seal has to be replaced from time to time.

Accuracy test

Accuracy tests of the flow meter should be carried out in the frame of your in-house quality assurance.

A regular calibration by the Anderson-Negele Service Engineers increases the reliability of the measuring instrument.

10.2.1 Preventive maintenance steps

A regular and careful maintenance of the measuring spot (flow meter in its fitting situation) is indispensable in order:

- To avert any danger for persons and the environment
- Not to endanger the product quality
- Not to reduce the service life of the system and its components

The preventive maintenance steps for the flow meter type FMQ refer to the **seals of the pipe connections**.

The recommended maintenance intervals result from the experience in other systems. However, the really required maintenance intervals can considerably differ from that experience for the following reasons:

- Daily running time and number of the annual production days
- Aggressiveness of the media
- Frequency of cleaning phases, especially with hot water and caustic solution as well as disinfectants
- Duration and temperature of the cleaning phases
- Possible drying on of product residuals

Anderson-Negele recommends checking the measuring spot continuously, i.e.:

The **operators** of the system should **currently** pay attention to:

- occurring leaks
- unusual measuring results

Regular maintenance:

Following different strategies suggest themselves:

1. A consequent replacement of **all** seals and wearing parts in regular intervals, e.g. every year. Exceptions have to be allowed as a matter of course.
2. Replacement of heavier stressed seals and wearing parts in short intervals (e.g. once a year) and of less stressed parts in larger intervals (e.g. every 2 years). It is important that the serviced components are marked accordingly.
3. Exchange of the seals and wearing parts when required (e.g. when leaks occur). On that occasion it is reasonable to replace the wearing parts in the whole adjoining area, especially of the strongly stressed parts. It is indispensable to mark the serviced components accordingly.

4. Accuracy tests of the flow meters of the system in regular intervals in the frame of the inhouse quality/metrology standards. Of course, the aforesaid regular maintenance work can be carried out by the specialists of the Anderson-Negele service department, if preferred.

10.3 Repairs

10.3.1 Sending-in the flow meter to the manufacturer

If repairs have to be carried out at the factory, the following conditions will have to be fulfilled in order to enable a quick and cost-effective settlement.

- The components/devices have to be packed in such a way that damage in transit is excluded.
- The forms “**Fault Location Report**” and “**Declaration of Product Safety**” which you will find in the appendix of this instruction manual have to be completed and added to the delivery of the components/devices to be repaired.
- Without those form the handling of the repairs could be delayed by superfluous queries.

Warning:

- Do not send back to the manufacturer any measuring devices, if you are not absolutely sure that you could completely remove before any harmful substances which are detrimental to health, e.g. such substances which penetrated through gaps or slots or which diffused through plastic material!
- A RMA “returned materials authorization” needs to be completed online and referenced in the returned shipment.

Warning:

- Do not send back to the manufacturer any measuring devices, if you are not absolutely sure that you could completely remove before any harmful substances which are detrimental to health, e.g. such substances which penetrated through gaps or slots or which diffused through plastic material!
- The user of the flow meter will be charged for such costs arising for a potential disposal of the device or for personal injuries (e.g. chemical burns, etc.) caused by the device as a result from an insufficient or missing cleaning before sending in the flow meter to the manufacturer.

10.3.2 Repair work

Repairs are allowed to be carried out by skilled and accordingly trained personnel only. Interventions in the electronic boards are impossible. Only complete converters can be exchanged.

For each repair it is indispensable to strictly observe the general maintenance safety instructions.

A replacement of components in the fitting position should be avoided for the following reasons:

- Lock washers could drop out and be left on the electronic part when the fastening screws are loosened.
- Metal particles could destroy the electronic part when the power supply is switched on.
- When the electronic housing is open there is the risk that moisture could drip down onto the electronic boards. Moisture immediately destroys the electronic part when the power supply is switched on.

For all kinds of repairs the flow meter has to be definitely separated from the power supply!

10.3.2.1 Replacement of the sealing cover of the operating unit

The sealing cover will have to be replaced if the front pane is destroyed or scratched and if the operating unit does not function.

10.3.2.2 Replacement of the transmitter

Before replacing the transmitter, ensure that the pipe system is empty and unpressurized!
Flush the pipe system before the removal of the transmitter with clear cold water in order to avoid any residues of chemicals or elevated temperatures.

The distribution voltage for the electronic part has to be switched off.

Carry out a zero point measurement (“**ZERO adjust**“) with the new transmitter in order to optimize the accuracy of the flow meter!

10.4 Special program functions

The program of the FMQ offers some functions that could support a troubleshooting process.

Moreover, it is possible to use those functions for the adjustment and verification of connected devices.

10.4.1 Flow simulation

As an adjusting aid or for diagnosing purposes of connected devices the FMQ offers the possibility to simulate flow without any flowing product.

10.4.2 Simulation via the display unit

Select the “SIMULATION” function by means of the keypad

During the simulation the analog output is set to 12.0 mA (4...20 mA setting) or 10.0 mA (0...20mA setting).

The volume pulses are produced for the flow of 50 % according to the set pulse value.

10.5 Spare parts to be kept available on your stock

The spare parts list results from the experience in the different applications of the flow meter. However, the actually required spare parts may be deviating from it for the following reasons:

- Daily running time and number of the annual production days
- Aggressiveness of the media
- Frequency of the required cleaning phases, especially with hot water, caustic solution, and disinfectants
- Duration and temperature of the cleaning phases

ITEM	PART NUMBER	DESCRIPTION
1	SEE TABLE 2	FLOWTUBE
2	SEE TABLE 2	ADAPTORS
3	SEE TABLE 2	ADAPTOR O-RINGS
4	33720T200908	ADAPTOR BOLTS 3/4" THRU 2-1/2"
	33720T2009010	ADAPTOR BOLTS 3" & 4"
5	45678M0809	ADAPTOR WASHERS 3/4" THRU 2-1/2"
	45678M1009	ADAPTOR WASHERS 3" & 4"
6	33720T120906	HOUSING BOLTS
7	45678M0609	HOUSING WASHERS

TABLE 1

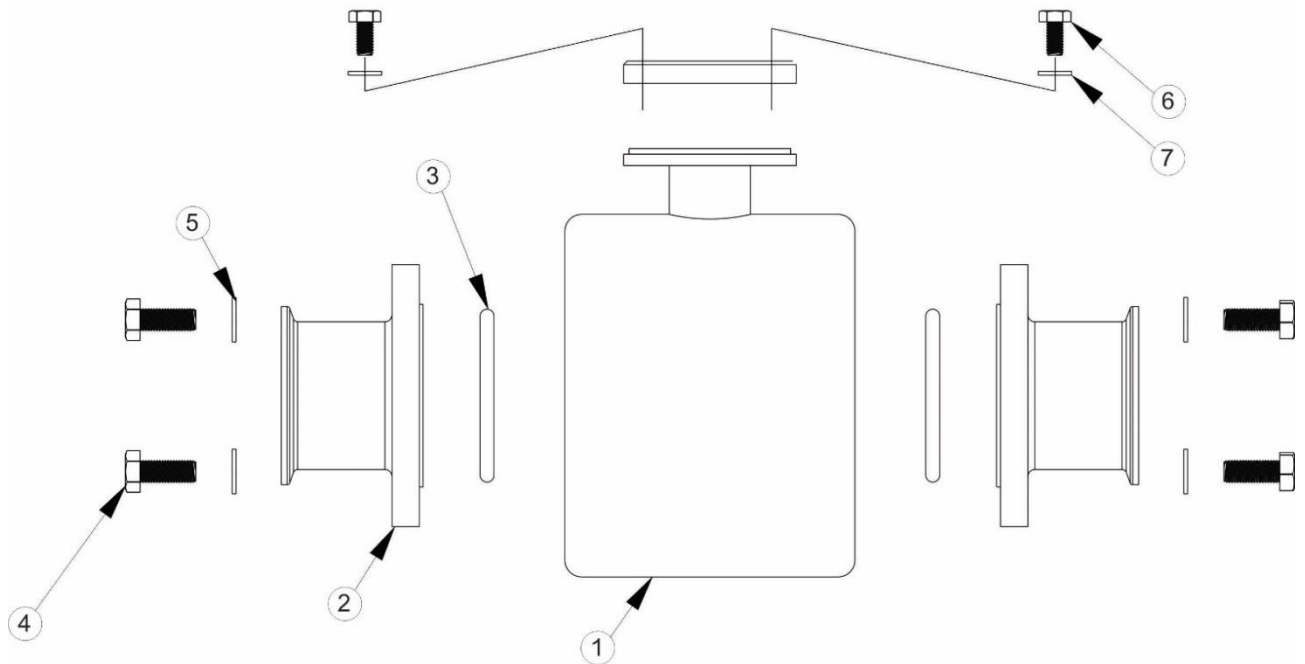

Size	Flow tube	Adapters			Orings	
		DIN 11864-2 Butt Weld Flange	ASME Clamp Connection	DIN Clamp Connection	EPDM	Silicone
010	IZAG010XX0	45672A0010	56721A0010	56721G0010	45669A0010	45669B0010
015	IZAG015XX0	45672A0015	56721A0015	56721G0015	45669A0015	45669B0015
025	IZAG025XX0	45672A0025	56721A0025	56721G0025	45669A0025	45669B0025
032	IZAG032XX0	45672A0032	56721A0032	56721G0032	45669A0032	45669B0032
040	IZAG040XX0	45672A0040	56721A0040	56721G0040	45669A0040	45669B0040
050	IZAG050XX0	45672A0050	56721A0050	56721G0050	45669A0050	45669B0050
065	IZAG065XX0	45672A0065	56721A0065	56721G0065	45669A0065	45669B0065
080	IZAG080XX0	45672A0080	56721A0080	56721G0080	45669A0080	45669B0080
100	IZAG100XX0	45672A0100	56721A0100	56721G0100	45669A0100	45669B0100

TABLE 2

Converter:

Item	PART NUMBER	DESCRIPTION
1	44886A0001	CAP ITM
2	87004A0001	SS Blind Cap
3	44887A0001	WINDOW ITM
4	56869A0001	FMQ HSG ASY, Graphic Display, IO-Link, M12 SS 4 Pin
5	56870A0001	FMQ HSG ASY, Graphic Display, IO-Link, M12 SS 5 Pin
6	56871A0001	FMQ HSG ASY, Graphic Display, Non-IO-Link, M12 SS 4 Pin
7	56872A0001	FMQ HSG ASY, Graphic Display, Non-IO -Link, M12 SS 5 Pin

11 Decommissioning

11.1 Temporary decommissioning

If the device is to be put out of operation for a temporary period only, no special measures have to be observed for its later recommissioning.

If the transmitter is removed from the process line, the pipe system first has to be emptied and depressurized.

Before removing the transmitter flush the pipe system with clear cold water in order to avoid any residues of chemicals or elevated temperatures.

Attach the covers for the protection of the liner.

11.2 Final decommissioning / disposal

If the whole device is defective beyond repair, you should take into account for the final decommissioning that wastes, contrivances, and system components to be scraped will have to be disposed of according to the valid laws, decrees, and regulations for waste disposal.

Note



The contents of this document are the intellectual property of Anderson-Negele. Any reproduction or translation without written permission is prohibited.

Please read these installation and operating instructions carefully. All instructions in this manual must be followed exactly to ensure proper operation of the unit.

If you have any questions regarding the product, installation or commissioning, please contact Anderson-Negele Support at support under:

America:
Phone 800-833-0081
techservice@anderson-negele.com

Other countries:
Phone +49-8333-9204720
support@anderson-negele.com